

PAPER TOWEL DISPENSER WP114



298 x 298 x 110 mm

approx. 250 paper towels

- Paper towel dispenser in robust, germ-reducing and easy-care stainless steel (AISI 304).
- All-stainless steel housing; all corners fully welded, visible surfaces satin finished and brushed. Further available surfaces: see below.
- With deep-drawn paper removal opening for easy paper removal.
- Designed for approx. 250 standard paper towels in zigzag fold. Paper size (folded): 240-250 mm x 100-115 mm.
- Inspection slot to indicate fill level.
- Accessible for refilling through lockable front flap with fall protection.
- Keyed alike cylinder lock in corrosion-resistant zinc die-casting.
- Wear parts can be replaced as modules.
- Installation dimensions: 300 x 300 x 110 mm
- Mounting: With four screws in wall opening through fixing holes in the side walls.
- Delivery includes fixing material and one pack of paper towels.
- Weight, including single package: 3.7 kg



Suggested text for specifications:

Paper towel dispenser in stainless steel (AISI 304) for flush mounting. All-stainless steel housing; all corners fully welded, visible surfaces satin finished and brushed. With deep-drawn paper removal opening, filling quantity approx. 250 paper towels. Inspection slot to indicate fill level. Accessible for refilling through lockable front flap with fall protection. Keyed alike cylinder lock in corrosion-resistant zinc die-casting. Delivery includes fixing material and one pack of paper towels.

Dimensions: 298 x 298 x 120 mm

Article No. WP114

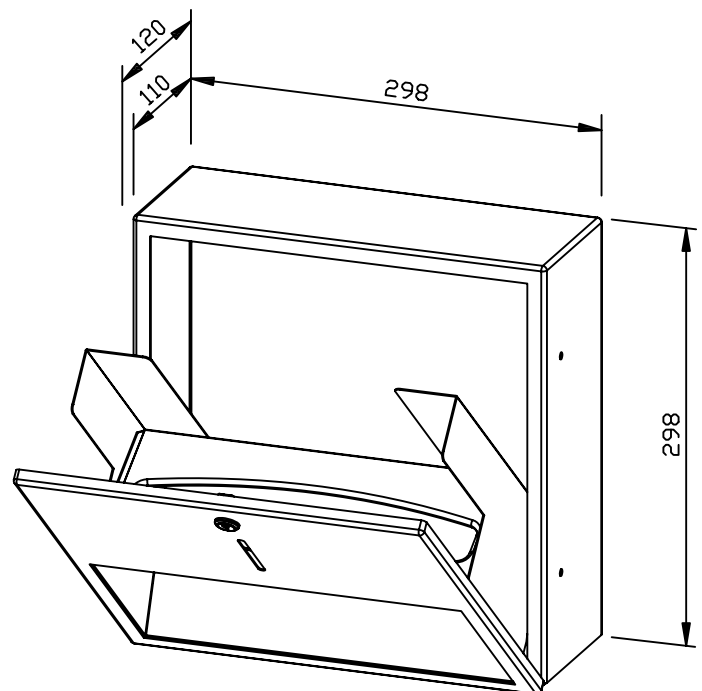

Available surfaces	ID No.
satin finished (standard)	727 570
highly polished	731 570
(coloured) plastic powder-coating	728 119

Ernst Wagner GmbH & Co. KG

Ernst-Abbe-Straße 21 · D-72770 Reutlingen · Tel.: +49712151539-0 · Fax: -20
info@wagner-ewar.de · www.wagner-ewar.de

WAGNER
EWAR